

KARTA PRODUKTÓW

WÓZKI

Wózki naszej produkcji wykonane ze stali nierdzewnej lub kwasoodpornej są dostępne w różnych wymiarach, kształtach i konfiguracjach. Wyposażamy zakłady przetwórstwa spożywczego: zakłady mięsne, mleczarskie, rybne, piekarnie i cukiernie, wylęgarnie, firmy z przemysłu medycznego.



wymiary

L	B	H
500	600	850
600	800	1150
	900	
	1000	

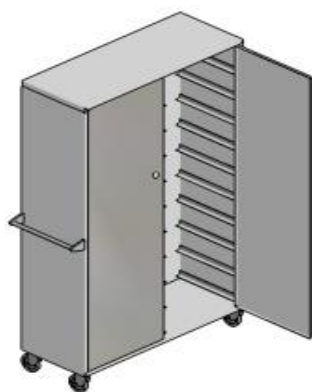

wymiary

L	B	H
650	1185	1610
	1585	

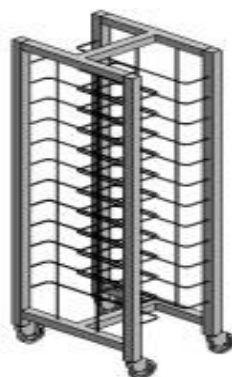

wymiary

L	B	H
400	540	1700
770		
1140		

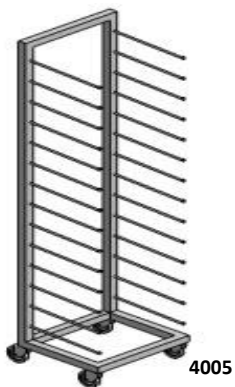

wymiary		
L	B	H
450	530	1800



wymiary		
L	B	H
700	1000	1955

4021



4007



4006

wymiary		
L	B	H
600	700	850
635	790	

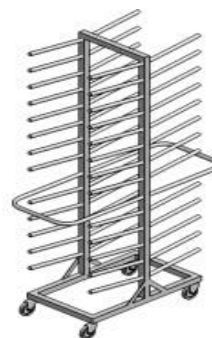

4004

wymiary		
L	B	H
500	830	1900



4001

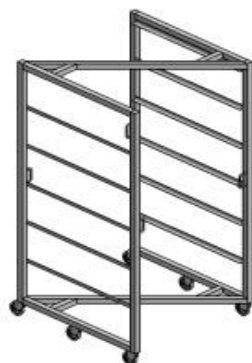

4002

wymiary		
L	B	H
1000	1000	1980

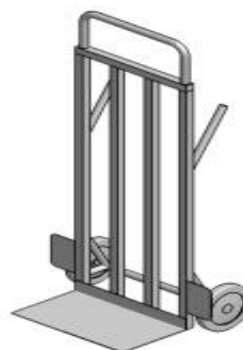

4017

wymiary		
L	B	H
260	450	1310



4016



4015

wymiary		
L	B	H
500	800	850
600	1000	
800	1200	

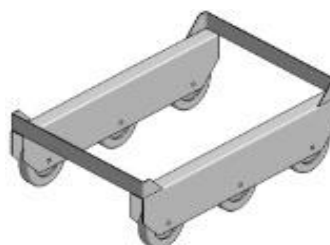

4018

wymiary		
L	B	H
260	450	1310



4019



4020

wymiary

L	B	H
600	900	800



4025

wymiary

L	B	H
260	450	1310

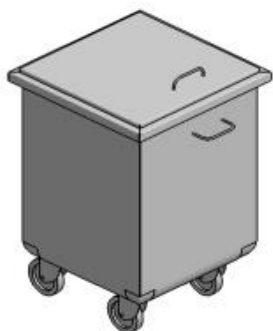

4023

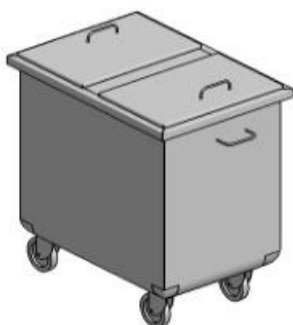

4024

wymiary

L	B	H
400	400	650
	500	850
	600	
	700	

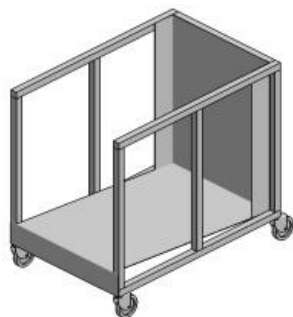

4022

wymiary

L	B	H
600	900	800

WIBO-BT Monika Bober-Kuchta

ul. Kolejowa 20
13-124 Kozłowo k. Nidzicy
Poland

www.wibo-bt.com.pl

telefony/ phone numbers:

sekretariat / office: +48 89 626 75 09
dział handlu / sales: +48 89 626 76 76
+48 604 271 805, +48 606 839 232,
+48 506 199 472, +48 668 039 281

fax: +48 89 626 75 00

mail: poczta@wibo-bt.com.pl

